

# LMV112

## 40 MHz Dual Clock Buffer

### General Description

The LMV112 is a high speed dual clock buffer designed for portable communications and accurate multi-clock systems. The LMV112 integrates two 40 MHz low noise buffers which optimizes application and out performs large discrete solutions. This device enables superb system operation between the base band and the oscillator signal path while eliminating crosstalk.

National Semiconductor's unique technology and design deliver accuracy, capacitance and load resistance while increasing the drive capability of the device. The low power consumption makes the LMV112 perfect for battery applications.

The robust, independent, and flexible buffers are designed to provide the customer with the ability to manage complex clock signals in the latest wireless applications. The buffers deliver 110 V/μs internal slew rate with independent shutdown and duty cycle precision. The patented analog circuit drives capacitive loads beyond 20 pF. National's proven biasing technique has 1V centering, rail-to-rail input/output unity gain, and AC coupled convenient inputs. These integrated cells save space and require no external bias resistors. National's rapid recovery after disable optimizes performance and current consumption. The LMV112 offers individual enable pin controls and since there is no internal ground reference either single or split supply configurations offer additional system flexibility and power choices.

The LMV112 is a proven replacement for any discrete circuitry and simplifies board layout while minimizing related parasitic components.

The LMV112 is produced in the small LLP package which offers high quality while minimizing its use of PCB space. National's advanced packaging offers direct PCB-IC evaluation via pin access.

### Features

(Typical values are:  $V_{SUPPLY} = 2.7V$  and  $C_L = 20 pF$ , unless otherwise specified)

- Small signal bandwidth 40 MHz
- Supply voltage range 2.4V to 5V
- Slew rate 110 V/μs
- Total supply current 1.6 mA
- Shutdown current 59 μA
- Rail-to-rail input and output
- Individual buffer enable pins
- Rapid  $T_{on}$  technology
- Crosstalk rejection circuitry
- 8-pin LLP, pin access packaging
- Temperature range -40°C to 85°C

### Applications

- 3G mobile applications
- WLAN-WiMAX modules
- TD\_SCDMA multi-mode MP3 and camera
- GSM modules
- Oscillator modules

### Typical Application

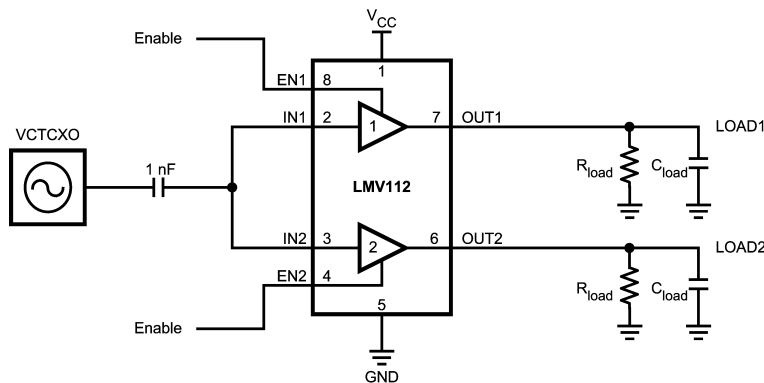

20135302

**Absolute Maximum Ratings** (Note 1)

If Military/Aerospace specified devices are required, please contact the National Semiconductor Sales Office/Distributors for availability and specifications.

Supply Voltages ( $V^+ - V^-$ )	5.5V
ESD Tolerance (Note 2)	
Human Body	2000V
Machine Model	200V
Storage Temperature Range	-65°C to +150°C
Junction Temperature (Note 3)	+150°C

## Soldering Information

Infrared or Convection (35 sec.) 235°C

**Operating Ratings** (Note 1)

Supply Voltage ( $V^+ - V^-$ )	2.4V to 5.0V
Temperature Range (Notes 3, 4)	-40°C to +85°C
Package Thermal Resistance (Notes 3, 4)	
LLP-8 ( $\theta_{JA}$ )	217°C/W

**2.7V Electrical Characteristics**

Unless otherwise specified, all limits are guaranteed for  $T_J = 25^\circ\text{C}$ ,  $V_{DD} = 2.7\text{V}$ ,  $V_{SS} = 0\text{V}$ ,  $V_{CM} = 1\text{V}$ ,  $\text{Enable}_{1,2} = V_{DD}$ ,  $C_L = 20\text{pF}$ ,  $R_L = 30\text{k}\Omega$ ,  $C_{COUPLING} = 1\text{nF}$ . **Boldface** limits apply at temperature range extremes of operating condition. See (Note 4)

Symbol	Parameter	Conditions	Min (Note 6)	Typ (Note 5)	Max (Note 6)	Units
<b>Frequency Domain Response</b>						
SSBW	Small Signal Bandwidth	$V_{IN} = 0.63 V_{PP}$ ; -3 dB		40		MHz
FPBW	Full Power Bandwidth	$V_{IN} = 1.6 V_{PP}$ ; -3 dB		28		MHz
GFN	Gain Flatness < 0.1 dB	$f > 100\text{ kHz}$		3.4		MHz
<b>Distortion and Noise Performance</b>						
$e_n$	Input-Referred Voltage Noise	$f = 1\text{ MHz}$		26		nV/ $\sqrt{\text{Hz}}$
$I_{ISOLATION}$	Output to Input	$f = 1\text{ MHz}$		91		dB
CT	Crosstalk Rejection	$f = 26\text{ MHz}$ , $P_{IN} = 0\text{ dBm}$		54		dB
<b>Time Domain Response</b>						
$t_r$	Rise Time	0.1 $V_{PP}$ Step (10-90%), $f = 1\text{ MHz}$		7		ns
$t_f$	Fall Time			6		ns
$t_s$	Settling Time to 0.1%	1 $V_{PP}$ Step, $f = 1\text{ MHz}$		118		ns
OS	Overshoot	0.1 $V_{PP}$ Step, $f = 1\text{ MHz}$		41		%
SR	Slew Rate (Note 7)	$V_{IN} = 1.6 V_{PP}$ , $f = 26\text{ MHz}$		110		V/ $\mu\text{s}$
<b>Static DC Performance</b>						
$I_S$	Supply Current	Enable <sub>1,2</sub> = $V_{DD}$ ; No Load		1.6	2.0 <b>2.1</b>	mA
		Enable <sub>1,2</sub> = $V_{SS}$ ; No Load		59	72 <b>78</b>	$\mu\text{A}$
PSRR	Power Supply Rejection Ratio	DC (3.0V to 5.0V)	58 <b>57</b>	68		dB
$A_{CL}$	Small Signal Voltage Gain	$V_{OUT} = 0.1 V_{PP}$	0.97 <b>0.95</b>	1.01	1.05 <b>1.07</b>	V/V
$V_{OS}$	Output Offset Voltage			0.4	16 <b>17</b>	mV
TC $V_{OS}$	Temperature Coefficient Output Offset Voltage (Note 8)			4		$\mu\text{V}/^\circ\text{C}$
$R_{OUT}$	Output Resistance	$f = 100\text{ kHz}$		0.5		$\Omega$
		$f = 26\text{ MHz}$		140		
<b>Miscellaneous Performance</b>						
$R_{IN}$	Input Resistance per Buffer	Enable = $V_{DD}$		141		k $\Omega$
		Enable = $V_{SS}$		141		
$C_{IN}$	Input Capacitance per Buffer	Enable = $V_{DD}$		2.3		pF
		Enable = $V_{SS}$		2.3		
$Z_{IN}$	Input Impedance	$f = 26\text{ MHz}$ , Enable = $V_{DD}$		10.4		k $\Omega$
		$f = 26\text{ MHz}$ , Enable = $V_{SS}$		10.9		

## 2.7V Electrical Characteristics (Continued)

Unless otherwise specified, all limits are guaranteed for  $T_J = 25^\circ\text{C}$ ,  $V_{DD} = 2.7\text{V}$ ,  $V_{SS} = 0\text{V}$ ,  $V_{CM} = 1\text{V}$ ,  $\text{Enable}_{1,2} = V_{DD}$ ,  $C_L = 20\text{pF}$ ,  $R_L = 30\text{k}\Omega$ ,  $C_{COUPLING} = 1\text{nF}$ . **Boldface** limits apply at temperature range extremes of operating condition. See (Note 4)

Symbol	Parameter	Conditions	Min (Note 6)	Typ (Note 5)	Max (Note 6)	Units
$V_O$	Output Swing Positive	$V_{IN} = V_{DD}$	2.65 <b>2.63</b>	2.69		V
	Output Swing Negative	$V_{IN} = V_{SS}$		10	50 <b>65</b>	mV
$I_{SC}$	Output Short-Circuit Current (Note 9)	Sourcing	-18 <b>-13</b>	-27		mA
		Sinking	20 <b>16</b>	30		
$V_{en\_hmin}$	Enable High Active Minimum Voltage			1.2		V
$V_{en\_lmax}$	Enable Low Inactive Maximum Voltage			0.6		

## 5V Electrical Characteristics

Unless otherwise specified, all limits are guaranteed for  $T_J = 25^\circ\text{C}$ ,  $V_{DD} = 5\text{V}$ ,  $V_{SS} = 0\text{V}$ ,  $V_{CM} = 1\text{V}$ ,  $\text{Enable}_{1,2} = V_{DD}$ ,  $C_L = 20\text{pF}$ ,  $R_L = 30\text{k}\Omega$ ,  $C_{COUPLING} = 1\text{nF}$ . **Boldface** limits apply at temperature range extremes of operating condition. See (Note 4)

Symbol	Parameter	Conditions	Min (Note 6)	Typ (Note 5)	Max (Note 6)	Units
--------	-----------	------------	-----------------	-----------------	-----------------	-------

### Frequency Domain Response

SSBW	Small Signal Bandwidth	$V_{IN} = 0.63 V_{PP}$ ; -3 dB		42		MHz
FPBW	Full Power Bandwidth	$V_{IN} = 1.6 V_{PP}$ ; -3 dB		31		MHz
GFN	Gain Flatness < 0.1 dB	$f > 100\text{kHz}$		4.9		MHz

### Distortion and Noise Performance

$e_n$	Input-Referred Voltage Noise	$f = 1\text{MHz}$		27		$\text{nV}/\sqrt{\text{Hz}}$
$I_{SOLATION}$	Output to Input	$f = 1\text{MHz}$		90		dB
CT	Crosstalk Rejection	$f = 26\text{MHz}$ , $P_{IN} = 0\text{dBm}$		61		dB

### Time Domain Response

$t_r$	Rise Time	$0.1 V_{PP}$ Step (10-90%), $f = 1\text{MHz}$		7		ns
$t_f$	Fall Time			6		ns
$t_s$	Settling Time to 0.1%	$1 V_{PP}$ Step, $f = 1\text{MHz}$		80		ns
OS	Overshoot	$0.1V_{PP}$ Step, $f = 1\text{MHz}$		20		%
SR	Slew Rate (Note 7)	$V_{IN} = 1.6 V_{PP}$ , $f = 26\text{MHz}$		120		$\text{V}/\mu\text{s}$

### Static DC Performance

$I_S$	Supply Current	$\text{Enable}_{1,2} = V_{DD}$ ; No Load		2.5	3.5 <b>3.8</b>	mA
		$\text{Enable}_{1,2} = V_{SS}$ ; No Load		62	80 <b>89</b>	
PSRR	Power Supply Rejection Ratio	DC (3.0V to 5.0V)	58 <b>57</b>	68		dB
$A_{CL}$	Small Signal Voltage Gain	$V_{OUT} = 0.1 V_{PP}$	0.99 <b>0.97</b>	1.00	1.01 <b>1.03</b>	V/V
$V_{OS}$	Output Offset Voltage			1.3	16 <b>17</b>	mV
$TC V_{OS}$	Temperature Coefficient Output Offset Voltage (Note 8)			3		$\mu\text{V}/^\circ\text{C}$
$R_{OUT}$	Output Resistance	$f = 100\text{kHz}$		0.5		$\Omega$
		$f = 26\text{MHz}$		118		

## 5V Electrical Characteristics (Continued)

Unless otherwise specified, all limits are guaranteed for  $T_J = 25^\circ\text{C}$ ,  $V_{DD} = 5\text{V}$ ,  $V_{SS} = 0\text{V}$ ,  $V_{CM} = 1\text{V}$ ,  $\text{Enable}_{1,2} = V_{DD}$ ,  $C_L = 20\text{pF}$ ,  $R_L = 30\text{k}\Omega$ ,  $C_{COUPLING} = 1\text{nF}$ . **Boldface** limits apply at temperature range extremes of operating condition. See (Note 4)

Symbol	Parameter	Conditions	Min (Note 6)	Typ (Note 5)	Max (Note 6)	Units
<b>Miscellaneous Performance</b>						
$R_{IN}$	Input Resistance per Buffer	Enable = $V_{DD}$		134		k $\Omega$
		Enable = $V_{SS}$		134		
$C_{IN}$	Input Capacitance per Buffer	Enable = $V_{DD}$		2.0		pF
		Enable = $V_{SS}$		2.0		
$Z_{IN}$	Input Impedance	f = 26 MHz, Enable = $V_{DD}$		7.2		k $\Omega$
		f = 26 MHz, Enable = $V_{SS}$		8.0		
$V_O$	Output Swing Positive	$V_{IN} = V_{DD}$	4.96 <b>4.94</b>	4.99		V
	Output Swing Negative	$V_{IN} = V_{SS}$		10	40 <b>55</b>	mV
$I_{SC}$	Output Short-Circuit Current (Note 9)	Sourcing	-40 <b>-28</b>	-68		mA
		Sinking	70 <b>50</b>	98		
$V_{en\_hmin}$	Enable High Active Minimum Voltage			1.2		V
$V_{en\_lmax}$	Enable Low Inactive Maximum Voltage			0.6		

**Note 1:** Absolute Maximum Ratings indicate limits beyond which damage to the device may occur. Operating Ratings indicate conditions for which the device is intended to be functional, but specific performance is not guaranteed. For guaranteed specifications and the test conditions, see the Electrical Characteristics Tables.

**Note 2:** Human Body Model: 1.5 k $\Omega$  in series with 100 pF. Machine Model: 0 $\Omega$  in series with 200 pF.

**Note 3:** The maximum power dissipation is a function of  $T_{J(MAX)}$ ,  $\theta_{JA}$ , and  $T_A$ . The maximum allowable power dissipation at any ambient temperature is  $P_D = (T_{J(MAX)} - T_A) / \theta_{JA}$ . All numbers apply for packages soldered directly onto a PC board.

**Note 4:** Electrical Table values apply only for factory testing conditions at the temperature indicated. Factory testing conditions result in very limited self-heating of the device such that  $T_J = T_A$ . There is no guarantee of parametric performance as indicated in the electrical tables under conditions of internal self-heating where  $T_J > T_A$ .

**Note 5:** Typical Values represent the most likely parametric norm.

**Note 6:** All limits are guaranteed by testing or statistical analysis.

**Note 7:** Slew rate is the average of the positive and negative slew rate.

**Note 8:** Average Temperature Coefficient is determined by dividing the changing in a parameter at temperature extremes by the total temperature change.

**Note 9:** Short-Circuit test is a momentary test. Continuous short circuit operation at elevated ambient temperature can result in exceeding the maximum allowed junction temperature of 150 $^\circ\text{C}$ .

## Block Diagram

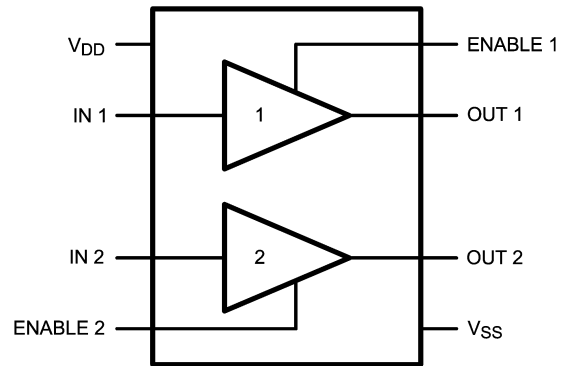

20135301

## Pin Description

Pin No.	Pin Name	Description
1	V <sub>DD</sub>	Voltage supply connection
2	IN 1	Input 1
3	IN 2	Input 2
4	ENABLE 2	Enable buffer 2
5	V <sub>SS</sub>	Ground connection
6	OUT 2	Output 2
7	OUT 1	Output 1
8	ENABLE 1	Enable buffer 1

## Connection Diagram

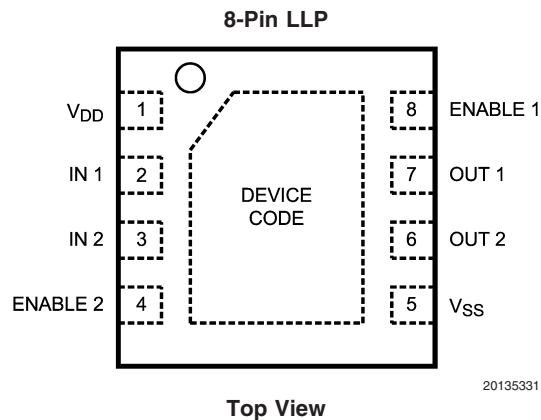

20135331

## Ordering Information

Package	Part Number	Package Marking	Transport Media	NSC Drawing
8-Pin LLP No Pull Back	LMV112SD	112SD	1k Units Tape and Reel	SDA08A
	LMV112SDX		4.5k Units Tape and Reel	

**Typical Performance Characteristics**  $T_J = 25^\circ\text{C}$ ,  $V_{DD} = 2.7\text{V}$ ,  $V_{SS} = 0\text{V}$ ,  $\text{Enable}_{1,2} = V_{DD}$ ,  $C_L = 20\text{pF}$ ,  $R_L = 30\text{k}\Omega$  and  $C_{\text{COUPLING}} = 1\text{nF}$ , unless otherwise specified.

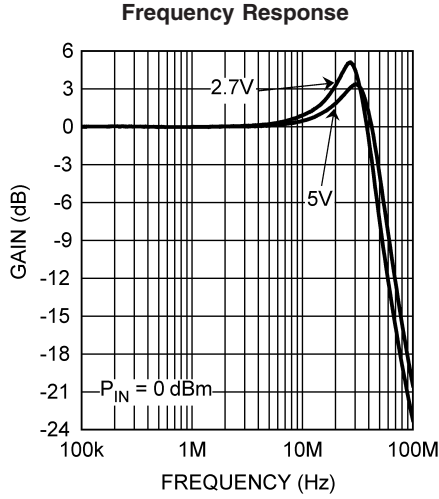

20135303

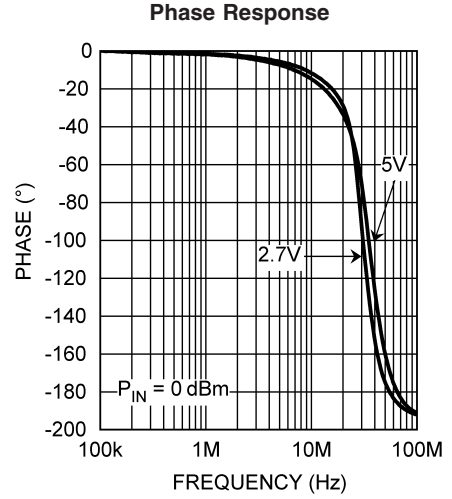

20135304

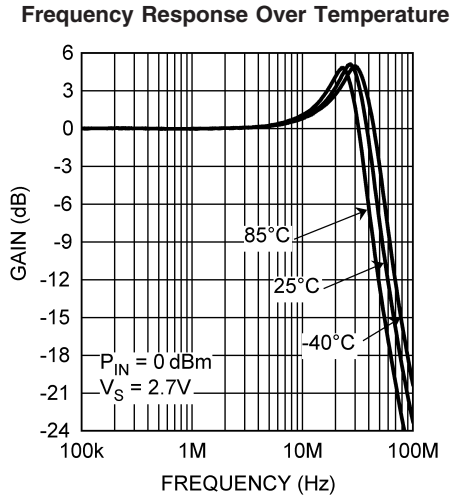

20135305

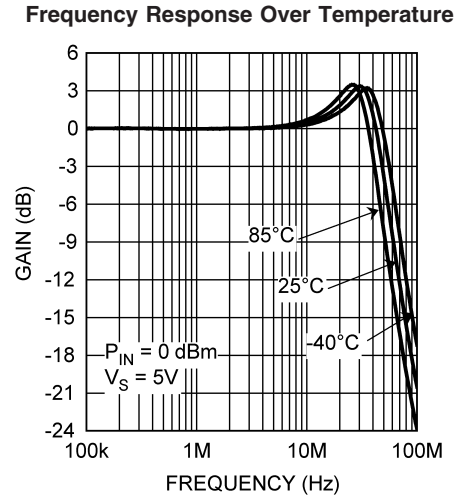

20135306

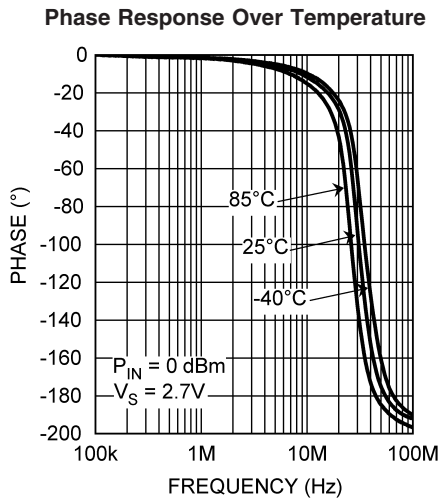

20135307

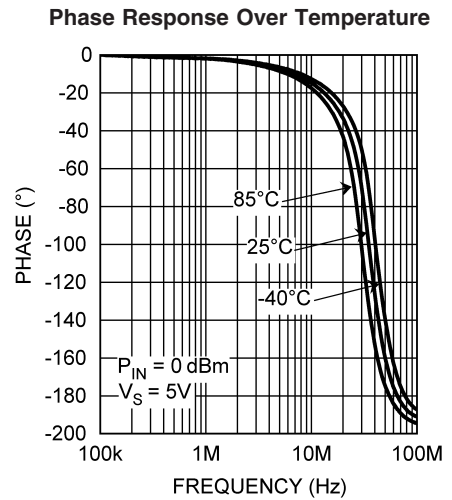

20135308

**Typical Performance Characteristics**  $T_J = 25^\circ\text{C}$ ,  $V_{DD} = 2.7\text{V}$ ,  $V_{SS} = 0\text{V}$ ,  $\text{Enable}_{1,2} = V_{DD}$ ,  $C_L = 20\text{pF}$ ,  $R_L = 30\text{k}\Omega$  and  $C_{\text{COUPLING}} = 1\text{nF}$ , unless otherwise specified. (Continued)

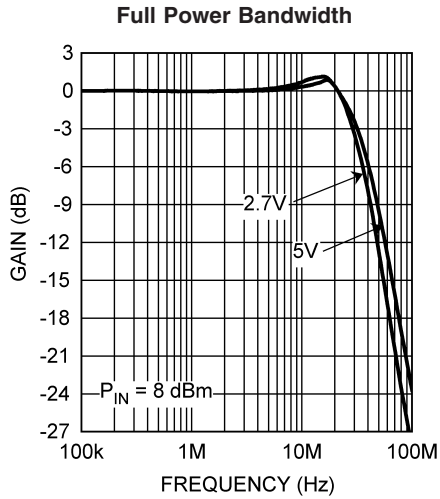

20135310

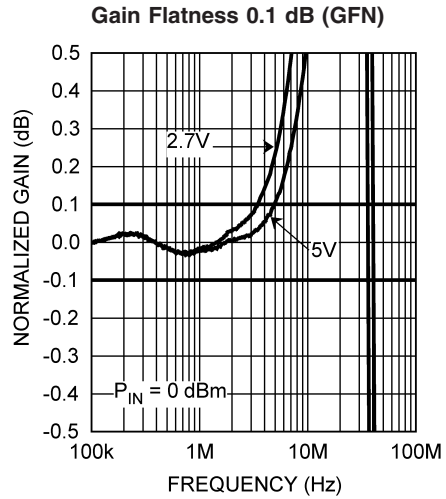

20135309

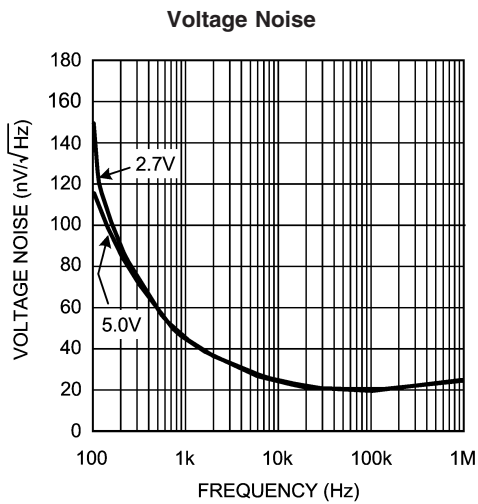

20135329

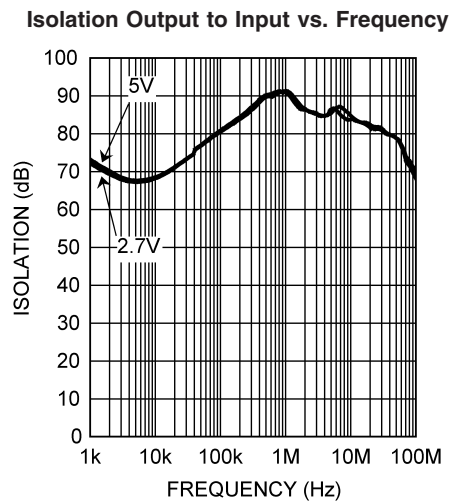

20135317

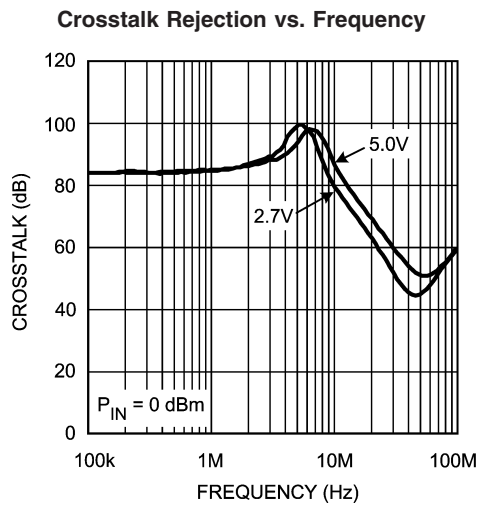

20135314

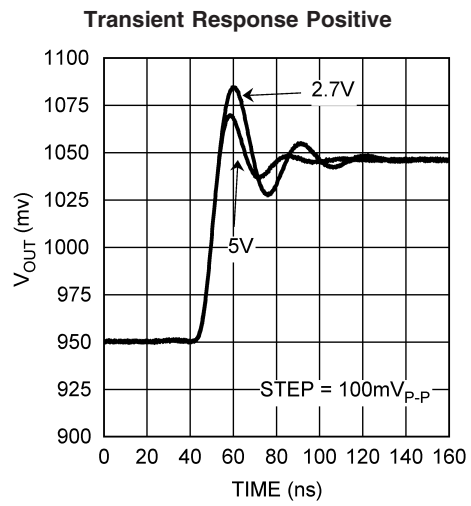

20135311

**Typical Performance Characteristics**  $T_J = 25^\circ\text{C}$ ,  $V_{DD} = 2.7\text{V}$ ,  $V_{SS} = 0\text{V}$ ,  $\text{Enable}_{1,2} = V_{DD}$ ,  $C_L = 20\text{pF}$ ,  $R_L = 30\text{k}\Omega$  and  $C_{\text{COUPLING}} = 1\text{nF}$ , unless otherwise specified. (Continued)

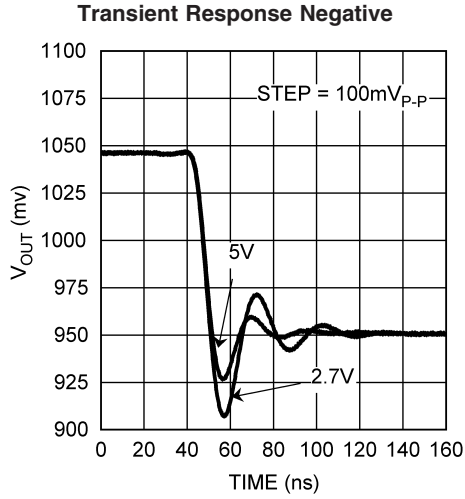

20135312

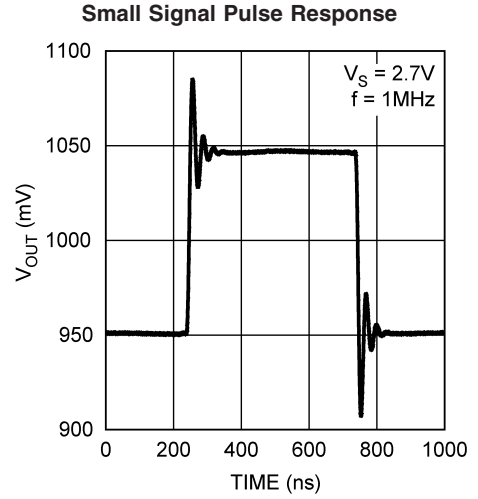

20135325

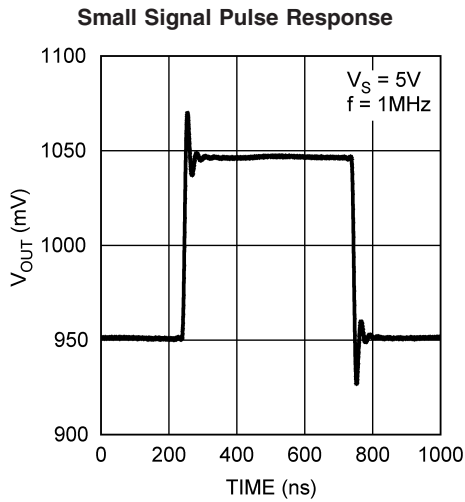

20135326

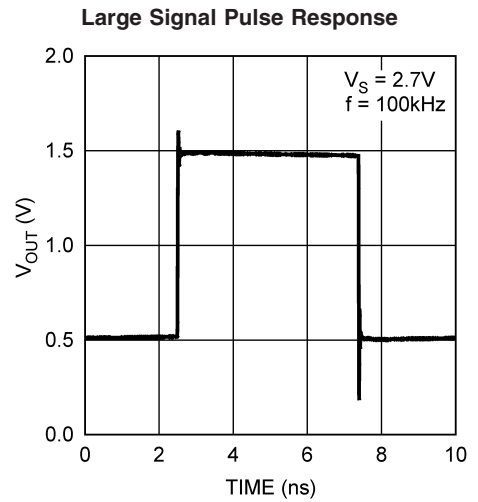

20135327

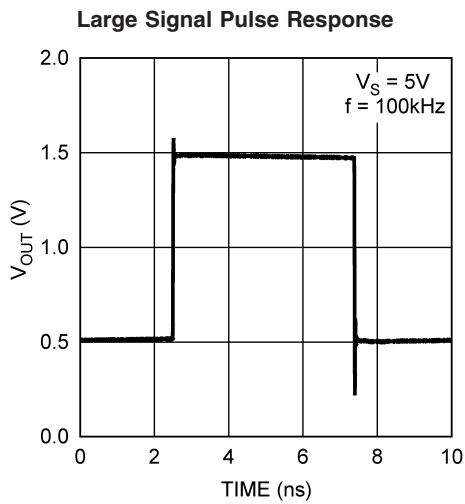

20135328

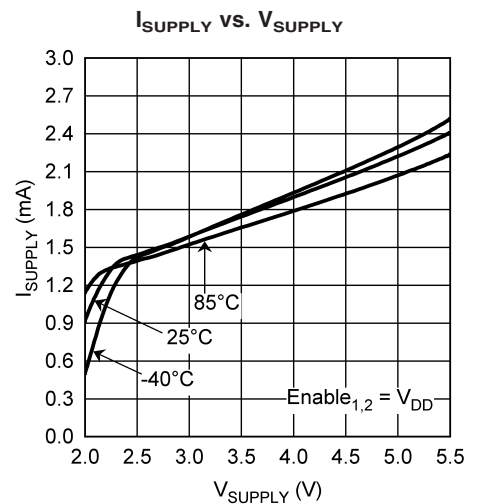

20135332



**Typical Performance Characteristics**  $T_J = 25^\circ\text{C}$ ,  $V_{DD} = 2.7\text{V}$ ,  $V_{SS} = 0\text{V}$ ,  $\text{Enable}_{1,2} = V_{DD}$ ,  $C_L = 20\text{pF}$ ,  $R_L = 30\text{k}\Omega$  and  $C_{\text{COUPLING}} = 1\text{nF}$ , unless otherwise specified. (Continued)

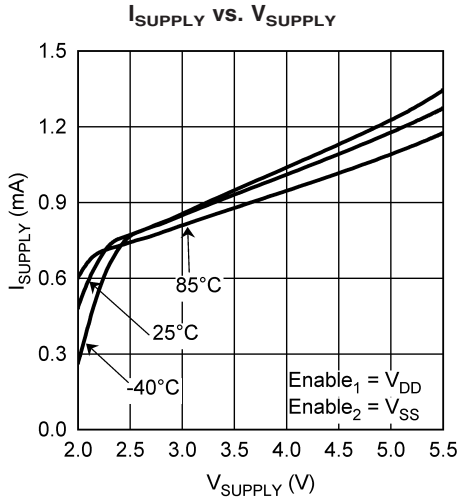

20135333

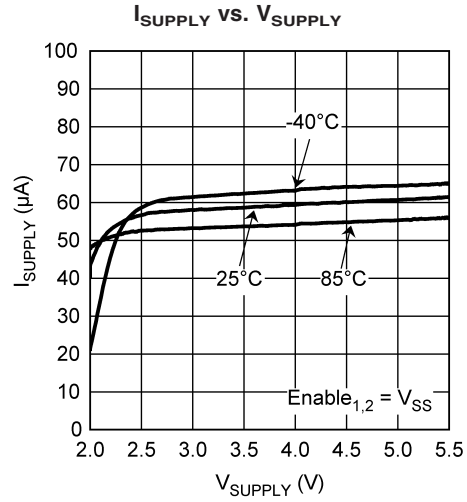

20135334

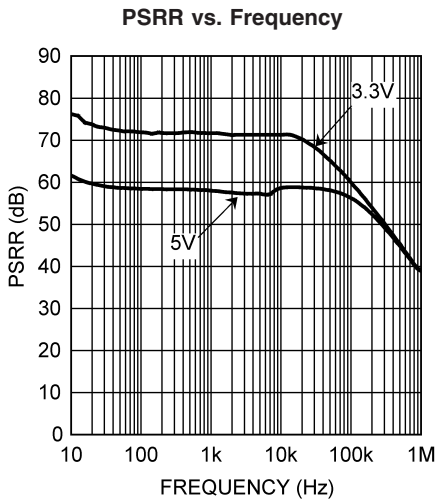

20135324

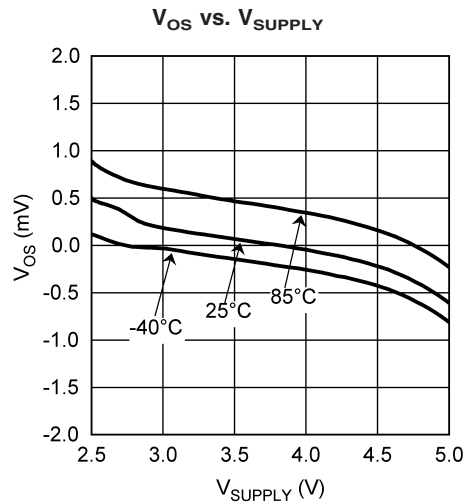

20135335

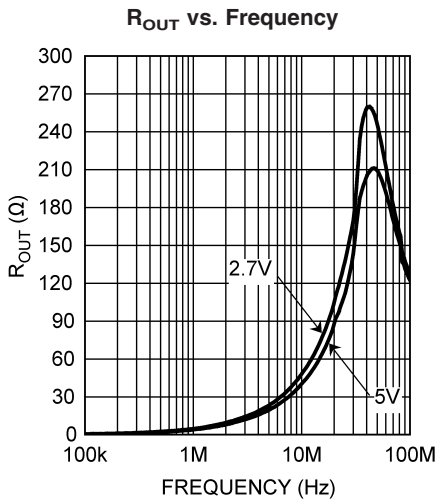

20135315

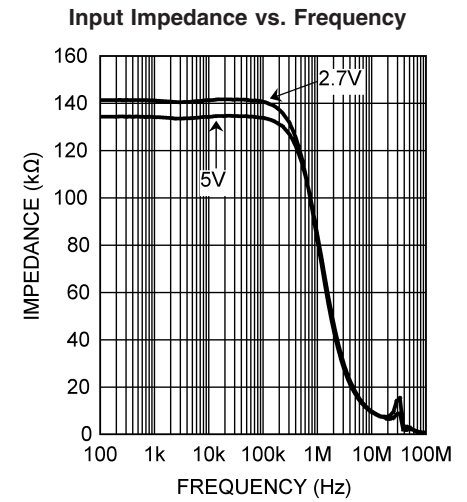

20135316

**Typical Performance Characteristics**  $T_J = 25^\circ\text{C}$ ,  $V_{DD} = 2.7\text{V}$ ,  $V_{SS} = 0\text{V}$ ,  $\text{Enable}_{1,2} = V_{DD}$ ,  $C_L = 20\text{ pF}$ ,  $R_L = 30\text{ k}\Omega$  and  $C_{\text{COUPLING}} = 1\text{ nF}$ , unless otherwise specified. (Continued)

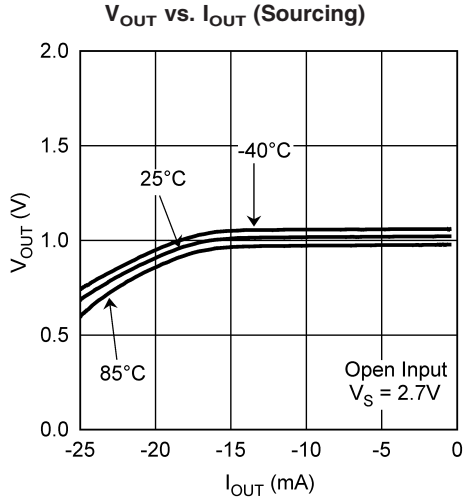

20135336

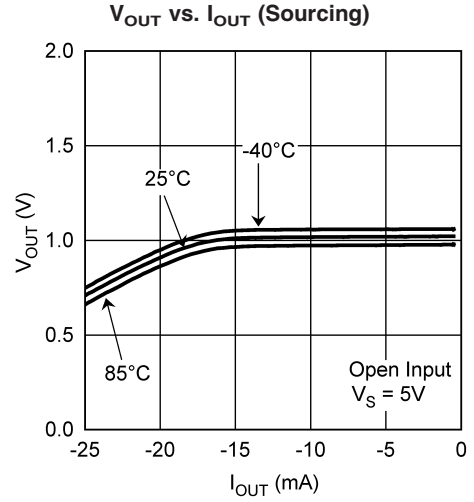

20135337

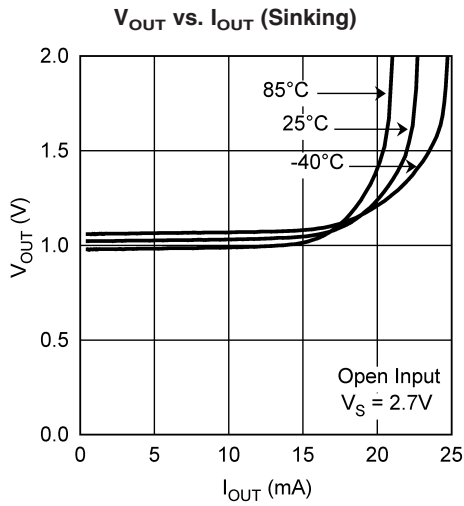

20135338

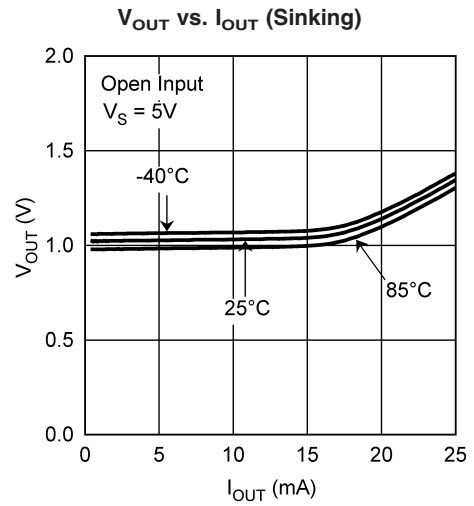

20135339

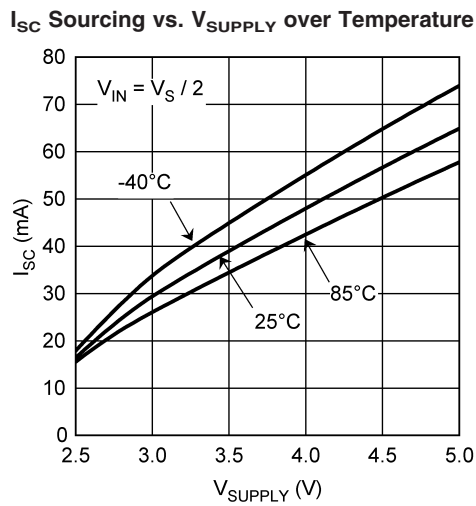

20135341

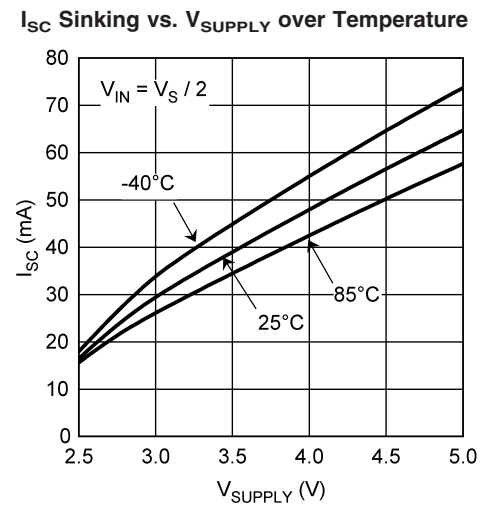

20135342

**Typical Performance Characteristics**  $T_J = 25^\circ\text{C}$ ,  $V_{DD} = 2.7\text{V}$ ,  $V_{SS} = 0\text{V}$ ,  $\text{Enable}_{1,2} = V_{DD}$ ,  $C_L = 20\text{pF}$ ,  $R_L = 30\text{k}\Omega$  and  $C_{\text{COUPLING}} = 1\text{nF}$ , unless otherwise specified. (Continued)

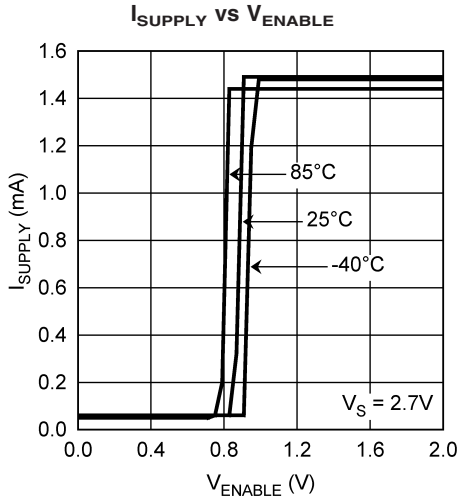

20135347

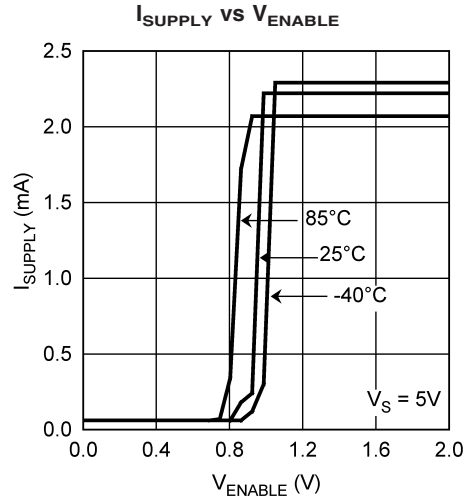

20135348

## Application Section

### GENERAL

The LMV112 is designed to minimize the effects of spurious signals from the base band chip to the oscillator. Also the influence of varying load resistance and capacitance to the oscillator is minimized, while the drive capability is increased.

The inputs of the LMV112 are internally biased at 1V, making AC coupling possible without external bias resistors.

To optimize current consumption, the buffer not in use can be disabled by connecting the enable pin to  $V_{SS}$ .

The LMV112 has no internal ground reference; therefore, either single or split supply configurations can be used.

The LMV112 is an easy replacement for discrete circuitry. It simplifies board layout and minimizes the effect of layout related parasitic components.

### INPUT CONFIGURATION

AC coupling is made possible by biasing the input. A large DC load at the oscillator input could change the load impedance and therefore its oscillating frequency. To avoid external resistors the inputs are internally biased. This biasing is set at 1V as depicted in *Figure 1*. Because this biasing is set at 1V, the maximum amplitude of the AC signal is  $2 V_{PP}$ .

The coupling capacitance should be large enough to let the AC signal pass. This is a unity gain buffer with rail-to-rail inputs and outputs.

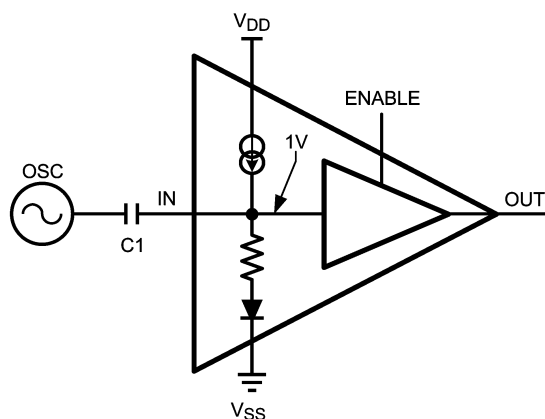

20135344

FIGURE 1. Input Configuration

### FREQUENCY PULLING

Frequency pulling is the frequency variation of an oscillator caused by a varying load. In the typical application, the load of the oscillator is a fixed capacitor (C1) and the input impedance of the buffer.

To keep the input impedance as constant as possible, the input is biased at 1V, even when the part is disabled. A simplified schematic of the input configuration is shown in *Figure 1*.

### ISOLATION AND CROSSTALK

Output to input isolation prevents the clock from being affected by spurious signals generated by the digital blocks at the output buffer. See the characteristic graphic entitled "Isolation Output to Input vs. Frequency."

A block diagram of the isolation is shown in *Figure 2*. Crosstalk rejection between buffers prevents signals from affecting each other. *Figure 2* shows a Base band IC and a Bluetooth module as examples of this. See the characteristic graphic labeled "Crosstalk Rejection vs. Frequency" for more information.

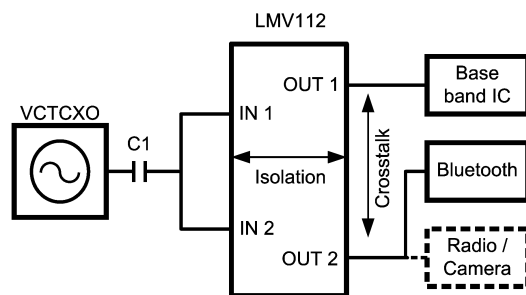

20135345

FIGURE 2. Isolation Block Diagram

### DRIVING CAPACITIVE LOADS

Each buffer can drive a capacitive load. Be aware that every capacitor directly connected to the output becomes part of the loop of the buffer. In most applications the load consists of the capacitance of copper tracks and the input capacitance of the application blocks. Capacitance reduces the gain/phase margin and increases the instability. It leads to peaking in the frequency response and in extreme situations oscillations can occur. To drive a large capacitive load it is recommended that a series resistor is included between the buffer and the load capacitor. The best value for this isolation resistance is often found by experimentation.

The LMV112 datasheet reflects measurements with capacitance loads of 20 pF at the output of the buffers. Most common applications will probably use a lower capacitance load, which will result in lower peaking and significantly greater bandwidth, see *Figure 3*.

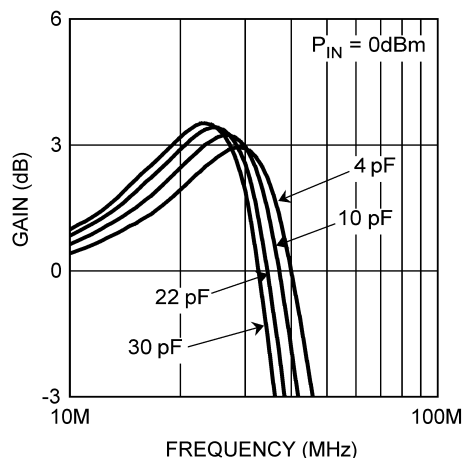

20135346

FIGURE 3. Bandwidth and Peaking

## Application Section (Continued)

### LAYOUT DESIGN RECOMMENDATION

Careful consideration for circuitry design and PCB layout will eliminate problems and will optimize the performance of the LMV112. It is best to have the same ground plane on the PCB for all power supply lines. This gives a low impedance return path for all decoupling and other ground connections.

To ensure a clean supply voltage it is best to place decoupling capacitors close to the LMV112, between  $V_{CC}$  and ground. The output of the VCO must be correctly terminated with proper load impedance.

Another important issue is the value of the components, which also determines the sensitivity to disturbances. Resistor values should be but avoid using values that cause a significant increase in power consumption while loading inputs or outputs to heavily.

**Physical Dimensions** inches (millimeters) unless otherwise noted

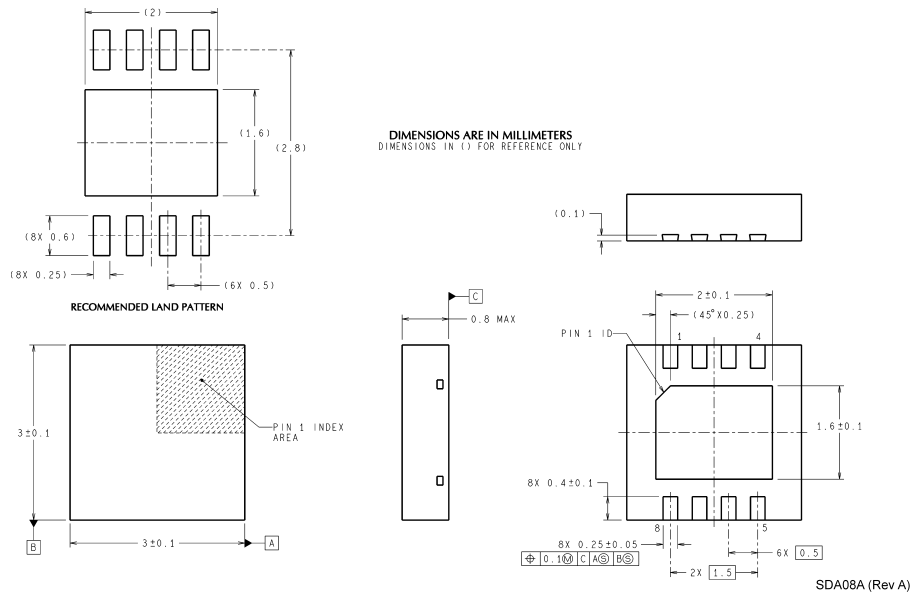

**8-Pin LLP  
NS Package Number SDA08A**

National does not assume any responsibility for use of any circuitry described, no circuit patent licenses are implied and National reserves the right at any time without notice to change said circuitry and specifications.

For the most current product information visit us at [www.national.com](http://www.national.com).

**LIFE SUPPORT POLICY**

NATIONAL'S PRODUCTS ARE NOT AUTHORIZED FOR USE AS CRITICAL COMPONENTS IN LIFE SUPPORT DEVICES OR SYSTEMS WITHOUT THE EXPRESS WRITTEN APPROVAL OF THE PRESIDENT AND GENERAL COUNSEL OF NATIONAL SEMICONDUCTOR CORPORATION. As used herein:

1. Life support devices or systems are devices or systems which, (a) are intended for surgical implant into the body, or (b) support or sustain life, and whose failure to perform when properly used in accordance with instructions for use provided in the labeling, can be reasonably expected to result in a significant injury to the user.
2. A critical component is any component of a life support device or system whose failure to perform can be reasonably expected to cause the failure of the life support device or system, or to affect its safety or effectiveness.

**BANNED SUBSTANCE COMPLIANCE**

National Semiconductor manufactures products and uses packing materials that meet the provisions of the Customer Products Stewardship Specification (CSP-9-111C2) and the Banned Substances and Materials of Interest Specification (CSP-9-111S2) and contain no "Banned Substances" as defined in CSP-9-111S2.

Leadfree products are RoHS compliant.

 **National Semiconductor**  
Americas Customer  
Support Center  
Email: [new.feedback@nsc.com](mailto:new.feedback@nsc.com)  
Tel: 1-800-272-9959

**National Semiconductor**  
Europe Customer Support Center  
Fax: +49 (0) 180-530 85 86  
Email: [europa.support@nsc.com](mailto:europa.support@nsc.com)  
Deutsch Tel: +49 (0) 69 9508 6208  
English Tel: +44 (0) 870 24 0 2171  
Français Tel: +33 (0) 1 41 91 8790

**National Semiconductor**  
Asia Pacific Customer  
Support Center  
Email: [ap.support@nsc.com](mailto:ap.support@nsc.com)

**National Semiconductor**  
Japan Customer Support Center  
Fax: 81-3-5639-7507  
Email: [jpn.feedback@nsc.com](mailto:jpn.feedback@nsc.com)  
Tel: 81-3-5639-7560